



Monitoring relays - GAMMA series
Multifunction
16.6 to 400Hz
Fault latch
Zoom voltage 24 to 240V a.c./d.c.
2 change-over contacts
Width 22.5mm
Industrial design



Technical data

1. Functions

a.c./d.c. voltage monitoring in 1-phase mains with adjustable thresholds, timing for start-up suppression and tripping delay separately adjustable and the following functions which are selected by means of rotary switch

OVER	Oversvoltage monitoring
OVER+LATCH	Oversvoltage monitoring with fault latch
UNDER	Undersvoltage monitoring
UNDER+LATCH	Undersvoltage monitoring with fault latch
WIN	Monitoring the window between Min and Max
WIN+LATCH	Monitoring the window between Min and Max with fault latch

2. Time ranges

	Adjustment range
Start-up suppression time:	0s 10s
Tripping delay:	0.1s 10s

3. Indicators

Green LED ON:	indication of supply voltage
Green LED flashes:	indication of start-up suppression time
Yellow LED ON/OFF:	indication of relay output
Red LED ON/OFF:	indication of failure of the corresponding threshold
Red LED flashes:	indication of tripping delay of the corresponding threshold

4. Mechanical design

Self-extinguishing plastic housing, IP rating IP40
Mounted on DIN-Rail TS 35 according to EN 60715
Mounting position: any
Shockproof terminal connection according to VBG 4 (PZ1 required), IP rating IP20
Tightening torque: max. 1Nm
Terminal capacity:
1 x 0.5 to 2.5mm² with/without multicore cable end
1 x 4mm² without multicore cable end
2 x 0.5 to 1.5mm² with/without multicore cable end
2 x 2.5mm² flexible without multicore cable end

5. Input circuit

Supply voltage:	24 to 240V a.c./d.c.	terminals A1-A2 (galvanically separated)
Tolerance:	24 to 240V d.c.	-20% to +25%
	24 to 240V a.c.	-15% to +10%
Rated frequency:	24 to 240V a.c.	48 to 400Hz
	48 to 240V a.c.	16 to 48Hz
Rated consumption:		4.5VA (1W)
Duration of operation:		100%
Reset time:		500ms
Wave form for a.c.:		Sinus
Residual ripple for d.c.:		10%
Drop-out voltage:		>15% of the supply voltage
Oversvoltage category:		III (in accordance with IEC 60664-1)
Rated surge voltage:		4kV

6. Output circuit

2 potential free change-over contacts	
Rated voltage:	250V a.c.
Switching capacity:	750VA (3A / 250V a.c.) If the distance between the devices is less than 5mm.
Switching capacity:	1250VA (5A / 250V a.c.) If the distance between the devices is greater than 5mm.
Fusing:	5A fast acting
Mechanical life:	20 x 10 ⁶ operations
Electrical life:	2 x 10 ⁵ operations at 1000VA resistive load
Switching frequency:	max. 60/min at 100VA resistive load max. 6/min at 1000VA resistive load (in accordance with IEC 60947-5-1)
Oversvoltage category:	III (in accordance with IEC 60664-1)
Rated surge voltage:	4kV

7. Measuring circuit

Fusing:	max. 20A (in accordance with UL 508)
Measured variable:	d.c. or a.c. Sinus (16.6 to 400Hz)
Input:	30V a.c./d.c. terminals E-F1(+) 60V a.c./d.c. terminals E-F2(+) 300V a.c./d.c. terminals E-F3(+)
Overload capacity:	100V _{Eff} 150V _{Eff} 300V a.c./d.c. 440V _{Eff}
Input resistance:	30V a.c./d.c. 47kΩ 60V a.c./d.c. 100kΩ 300V a.c./d.c. 470kΩ
Switching threshold	Max: 10% to 100% of U _N Min: 5% to 95% of U _N
Oversvoltage category:	III (in accordance with IEC 60664-1)
Rated surge voltage:	4kV

8. Accuracy

Base accuracy:	≤5% (of maximum scale value)
Frequency response:	-10% to +5% (at 16.6 to 400Hz)
Adjustment accuracy:	≤5% (of maximum scale value)
Repetition accuracy:	≤2%
Voltage influence:	-
Temperature influence:	≤0.05% / °C

9. Ambient conditions

Ambient temperature:	-25 to +55°C (in accordance with IEC 60068-1) -25 to +40°C (in accordance with UL 508)
Storage temperature:	-25 to +70°C
Transport temperature:	-25 to +70°C
Relative humidity:	15% to 85% (in accordance with IEC 60721-3-3 class 3K3)
Pollution degree:	3 (in accordance with IEC 60664-1)
Vibration resistance:	10 to 55Hz 0.35mm (in accordance with IEC 60068-2-6)
Shock resistance:	15g 11ms (in accordance with IEC 60068-2-27)

Functions

When the supply voltage U is applied, the output relays switch into on-position (yellow LED illuminated) and the set interval of the start-up suppression (START) begins (green LED U flashes). Changes of the measured voltage during this period do not affect the state of the output relay. After the interval has expired the green LED is illuminated steadily. For all the functions the LEDs MIN and MAX are flashing alternating, when the minimum value for the measured voltage was chosen to be greater than the maximum value.

Overvoltage monitoring (OVER, OVER+LATCH)

When the measured voltage exceeds the value adjusted at the MAX-regulator, the set interval of the tripping delay (DELAY) begins (red LED MAX flashes). After the interval has expired (red LED MAX illuminated), the output relays switch into off-position (yellow LED not illuminated). The output relays again switch into on-position (yellow LED illuminated), when the measured voltage falls below the value adjusted at the MIN-regulator (red LED MAX not illuminated). If the fault latch is activated (OVER+LATCH) and the measured voltage remains above the MAX-value longer than the set interval of the tripping delay, the output relays remain in the off-position even if the measured voltage falls below the value adjusted at the MIN-regulator. After resetting the failure (interrupting and re-applying the supply voltage), the output relays switch into on-position and a new measuring cycle begins with the set interval of the start-up suppression (START).

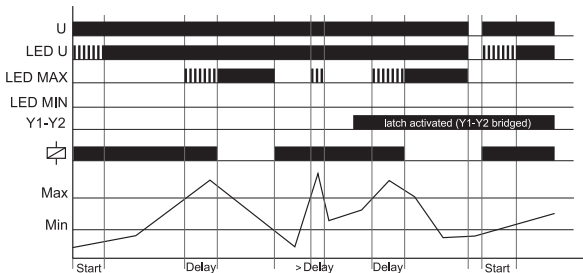

Undervoltage monitoring (UNDER, UNDER+LATCH)

When the measured voltage falls below the value adjusted at the MIN-regulator, the set interval of the tripping delay (DELAY) begins (red LED MIN flashes). After the interval has expired (red LED MIN illuminated), the output relays switch into off-position (yellow LED not illuminated). The output relays again switch into on-position (yellow LED illuminated), when the measured voltage exceeds the value adjusted at the MAX-regulator. If the fault latch is activated (UNDER+LATCH) and the measured voltage remains below the MIN-value longer than the set interval of the tripping delay, the output relays remain in the off-position even if the measured voltage exceeds the value adjusted at the MAX-regulator. After resetting the failure (interrupting and re-applying the supply voltage), the output relays switch into on-position and a new measuring cycle begins with the set interval of the start-up suppression (START).

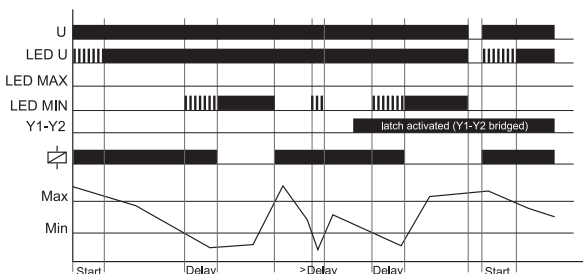

Window function (WIN, WIN+LATCH)

The output relays switch into on-position (yellow LED illuminated) when the measured voltage exceeds the value adjusted at the MIN-regulator. When the measured voltage exceeds the value adjusted at the MAX-regulator, the set interval of the tripping delay (DELAY) begins (red LED MAX flashes). After the interval has expired (red LED MAX illuminated), the output relays switch into off-position (yellow LED not illuminated). The output relays again switch into on-position (yellow LED illuminated) when the measured voltage falls below the value adjusted at the MAX-regulator (red LED MAX not illuminated). When the measured voltage falls below the value adjusted at the MIN-regulator, the set interval of the tripping delay (DELAY) begins again (red LED MIN flashes). After the interval has expired (red LED MIN illuminated), the output relays switch into off-position (yellow LED not illuminated).

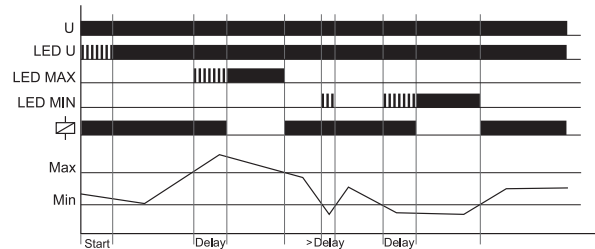

If the fault latch is activated (WIN+LATCH) and the measured voltage remains below the MIN-value longer than the set interval of the tripping delay, the output relays remain in the off-position even if the measured voltage exceeds the value adjusted at the MIN-regulator. If the measured voltage remains above the MAX-value longer than the set interval of the tripping delay, the output relays remain in the off-position even if the measured voltage falls below the value adjusted at the MAX-regulator. After resetting the failure (interrupting and re-applying the supply voltage), the output relays switch into on-position and a new measuring cycle begins with the set interval of the start-up suppression (START).

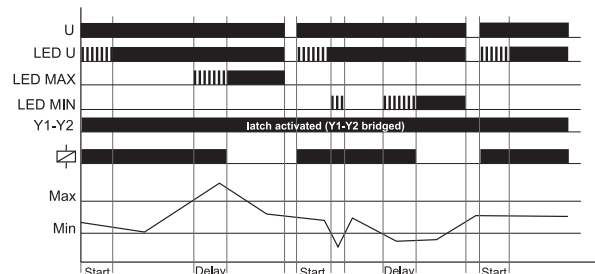

Connections

Range 30V, supply voltage 24V a.c./d.c. and fault latch

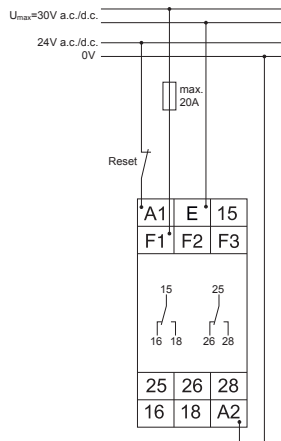

Dimensions

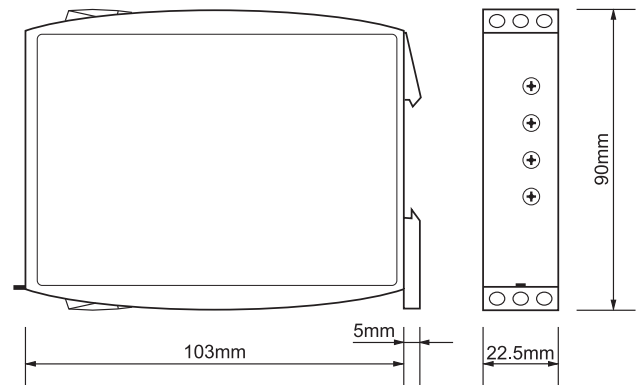

Range 60V, supply voltage 230V a.c. and fault latch

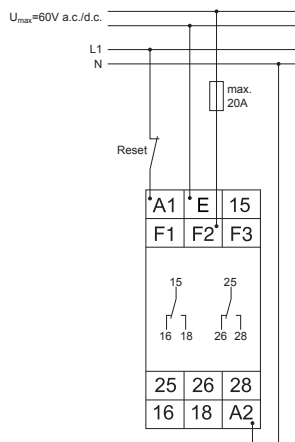

Range 300V, supply voltage 24V a.c./d.c. and fault latch

